

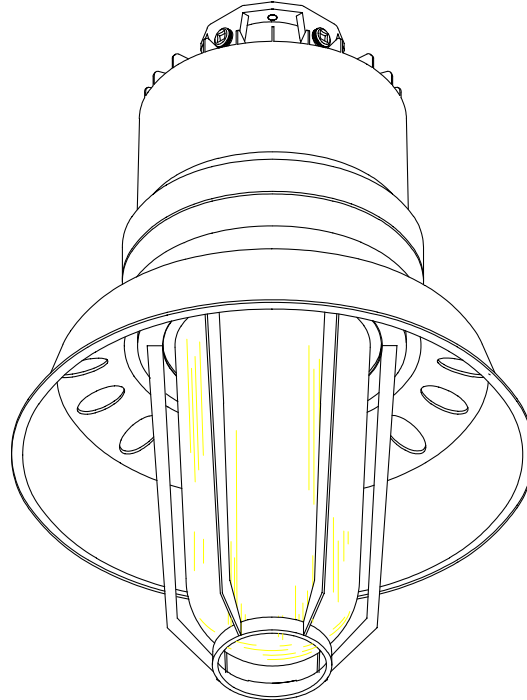

- CSA - Class I Div. 1 - Groups C & D
- CSA - Class I Div. 2 - Groups A, B, C & D
- CSA - Class II Div. 1 & 2 - Groups E, F & G
- CSA - Class III
- UL 844 - Class I Div. 1 - Groups C & D
- UL 844 - Class I Div. 2 - Groups A, B, C & D
- UL 844 - Class II Div. 1 & 2 - Groups E, F & G
- UL 844 - Class III
- UL Marine Listed, Nema 4X

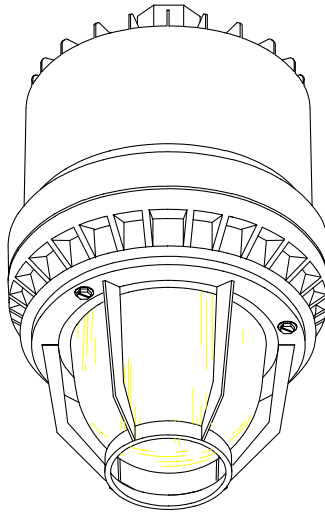

ZoneMax

Explosion Proof H.I.D Fixtures

Features:

- Excellent lumen efficiency (250/400 watt H.P.S. **efficiency 91.5%**). Lamp is located for maximum lumen output.
- Double pitch **ACME threads** on ballast housing to mount box & globe assembly to provide trouble free assembly and maintenance.
- 100% factory tested prestressed, tempered, **heat and impact resistant globes** (fluted for low glare).
- Electro-mechanical **disconnecting block** provides wireless assembly of ballast tank to outlet box.
- **Polyester powder coat** finish and stainless steel external hardware for corrosion resistance.
- UL or CSA listed **ballast** components are available in multi-tap or a wide range of single-tap voltages.
- Male connection block is pre-wired to ballast and secured to form the **factory seal** and to eliminate wire twisting.
- **Five mounting styles** available: (pendant, ceiling, wall, bulkhead and 25° stanchion).
- Optional **cast aluminum guard** available.
- Optional **dome or angle fiberglass reinforced polyester reflectors** are vented to allow convection of heat and provide up-light distribution to minimize glare.
- **Mounts are interchangeable** with ZoneMax II fixtures.

Applications:

- | | |
|--|---|
| <ul style="list-style-type: none"> ■ Chemical manufacturing / processing plants ■ Paint manufacturing facilities ■ Bulk truck terminals ■ Refineries | <ul style="list-style-type: none"> ■ Waste treatment plants ■ Marine loading terminals ■ Pipeline pumping stations ■ Solvent / cleaning areas |
|--|---|



ZoneMax

Catalog Number Logic

Z **H** **25** **C** **8** - **G** - **C2** ******
(1) (2) (3) (4) (5) (6) (7) (8)

(1) Series - ZoneMax "Z"

Polyester powder coated, cast aluminum, explosion proof HID fixture with tempered glass globe.

(2) Lamp Type (mogul base)

H - Metal Halide
S - High Pressure Sodium
V - Mercury Vapor

(3) Lamp Wattage

07 - 70 watts (HPS only)
10 - 100 watts (HPS only)
15 - 150 watts (HPS only)
17 - 175 watts (MH or MV only)
25 - 250 watts
40 - 400 watts

(4) Ballast Circuit (all ballasts high power factor)

C - Constant wattage autotransformer
H - High reactance

(5) Voltage/Frequency

2 - 220 Volt, 50 Hz.
6 - 480 Volt, 60 Hz.
7 - 120/208/240/277 Volt, 60 Hz. (UL only)
8 - 120/277/347 Volt, 60 Hz.

(6) Guard

G - Cast guard
(omit "G" if guard not required)

(7) Mounting Style

B2 - 3/4" npt. wall mount
B3 - 1" npt. wall mount
C2 - 3/4" npt. ceiling mount
C3 - 1" npt. ceiling mount
J2 - 3/4" npt. bulkhead mount
J3 - 1" npt. bulkhead mount
P2 - 3/4" npt. pendant mount
P3 - 1" npt. pendant mount
S4 - 1 1/4" npt. stanchion mount
S5 - 1 1/2" npt. stanchion mount

(8) Special Options

C - CSA nameplate (consult factory)
AR - Angle reflector
DD - Deep dome reflector
DR - Standard dome reflector
Q - Fixture with auxiliary quartz option
R - Fixture with instant restart option
(70, 100, and 150 watt HPS only)

Note: Lamps are not included.

Consult factory for any catalog number or options not listed above for price and availability.

ZoneMax

Certification Guide

Certification Guide (40° C Ambient)							
Lamp Type	Watts	Class I, Div. I Groups C & D Temp Codes*	Class II & III, Div. I & 2		UL Marine Listed	NEMA 4X	Supply Wire Temp.(°C)
			Temp. Codes*	Class II Groups			
High Pressure Sodium	70	T6	T4A	EFG	Yes	Yes	85
	100	T5	T4	EFG	Yes	Yes	85
	150	T4A	T3C	EFG	Yes	Yes	85
	250	T4A	--	--	Yes	Yes	85
	400	T3C	--	--	Yes	Yes	90
Metal Halide	175	T4A	T3A	EF	Yes	Yes	85
	250	T3C	T3	EF	Yes	Yes	90
	400	T3B	--	--	Yes	Yes	90
Mercury Vapor	175	T4	T3A	EF	Yes	Yes	85
	250	T3C	T3	EF	Yes	Yes	90
	400	T3A	--	--	Yes	Yes	90

* Temperature codes shown include globe, guard and reflector.



Fixture Components

ZoneMax Ballast Housing and Globe Assembly			
Lamp Type	Lamp Watts	Quad Tap UL Approved	Tri-Tap CSA Approved
High Pressure Sodium	70	ZS 07 H 7	ZS 07 H 8
	100	ZS 10 H 7	ZS 10 H 8
	150	ZS 15 H 7	ZS 15 H 8
	250	ZS 25 C 7	ZS 25 C 8
	400	ZS 40 C 7	ZS 40 C 8
Metal Halide	175	ZH 17 C 7	ZH 17 C 8
	250	ZH 25 C 7	ZH 25 C 8
	400	ZH 40 C 7	ZH 40 C 8
Mercury Vapor	175	ZV 17 C 7	ZV 17 C 8
	250	ZV 25 C 7	ZV 25 C 8
	400	ZV 40 C 7	ZV 40 C 8

Notes:
 Quad Tap ballast are 120 / 208 / 240 / 277 Volt 60 Hz
 Tri-Tap Ballast are 120 / 277 / 347 Volt 60 Hz
 For all other voltages consult factory

ZoneMax

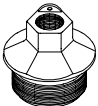
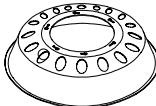
Fixture Components

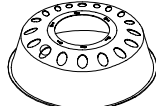
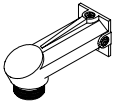
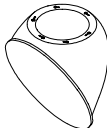
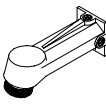
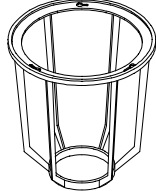
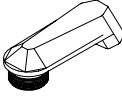
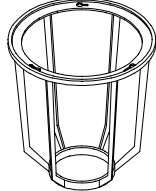
Mount Types	Hub Size	Catalog Number	Weight lbs/kg	Accessories	Catalog Number	Description	Weight lbs/kg
 Pendant	3/4"	ZXP2	2 lbs. (0.9 kg.)		RDP40	Standard dome fiberglass reinforced polyester	3.0 lbs. (1.4 kg.)
	1"	ZXP3					
 Ceiling	3/4"	ZXC2	4 lbs. (1.8 kg.)		RDD40	Deep dome Anodized aluminum finish	3.5 lbs. (1.6 kg.)
	1"	ZXC3					
 Wall	3/4"	ZXB2	5 lbs. (2.3 kg.)		RAP40	30° angle reflector Fiberglass reinforced polyester finish.	3.3 lbs. (1.5 kg.)
	1"	ZXB3					
 Bulkhead	3/4"	ZXJ2	5 lbs. (2.3 kg.)		GCZ25	Guard 150 W max. HPS 250 W max. MH/MV	1 lbs. (.45 kg.)
	1"	ZXJ3					
 Stanchion	1-1/4"	ZXS2	4 lbs. (1.8 kg.)		GCL40	Guard 250/400 W HPS & 400 W MH/MV	2 lbs. (0.9 kg.)
	1-1/2"	ZXJ3					

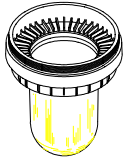
Replacement Globe & Ring Assembly	Catalog #	Description	Weight Each lbs. (kg.)
	ZXR25	For 150 watt max.HPS & 250 watt max.MH/MV	17 lbs. (7.7 kg.)
	ZXR40	For 250/400 watt HPS & 400 watt MH/MV	20 lbs. (9.1 kg.)

ZoneMax

Dimensions

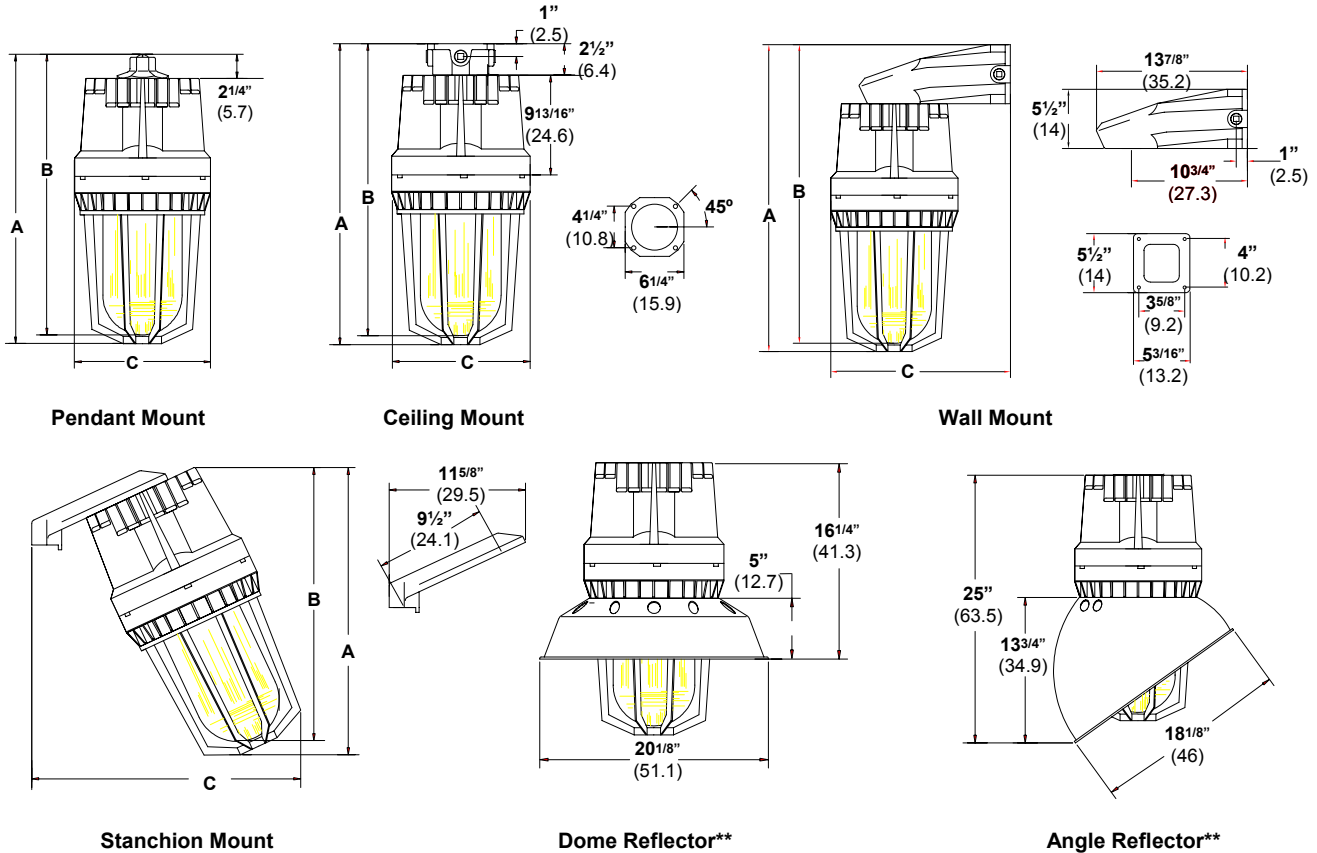

Mount	Watts / Lamp Type	A*	B*	C*	Weight
Pendant Mount	150 watt max. HPS				44lbs. (20 kg.)
	250 watt max.MH/MV	19.69 (50.0)	18.82 (46.0)	11.7 (29.7)	48/44lbs. (21.8/20.0 kg.)
Ceiling Mount	250/400 watt HPS	25.38 (64.4)	24.50 (62.2)	11.7 (29.7)	49/56lbs. (22.3/25.5 kg.)
	400 watt MH/MV	25.63 (65.0)	24.75 (62.9)	11.7 (29.7)	53/48lbs. (24.1/21.8 kg.)
Wall Mount	150 watt max. HPS	23.07 (58.6)	22.19 (56.4)	16.6 (42.2)	47lbs. (21.4 kg.)
	250 watt max.MH/MV	28.63 (72.7)	27.75 (70.5)	16.6 (42.2)	51/47lbs. (23.2/21.4 kg.)
Stanchion Mount	250/400 watt HPS	20.82 (52.9)	19.94 (50.6)	20.1 (51.0)	52/59lbs. (23.6/26.8 kg.)
	400 watt MH/MV	25.44 (64.6)	24.56 (62.4)	21.9 (55.6)	56/51lbs. (25.5/23.2 kg.)
Dome Reflector**	150 watt max. HPS				46lbs. (20.9 kg.)
	250 watt max.MH/MV	20.13 (51.1)	19.25 (48.9)	11.7 (29.7)	50/46lbs. (22.7/20.9 kg.)
Angle Reflector**	250/400 watt HPS	25.63 (65.0)	24.75 (62.9)	11.7 (29.7)	51/58lbs. (23.2/26.4 kg.)
	400 watt MH/MV	25.63 (65.0)	24.75 (62.9)	11.7 (29.7)	55/50lbs. (25.0/22.7 kg.)

Notes: Weights shown are for maximum wattage ballast listed.

* All dimensions are in inches (cm.)

** Please note that dimensions with dome and angle reflector are without mount. Please add dimensions for required mount.

ZoneMax

Parts Breakdown

